

SYNERGY 21[®]

"SYNERGY 2[®]" for black printing The pantone of Color is black c
 "1" for blue printing The pantone of Color is 298C

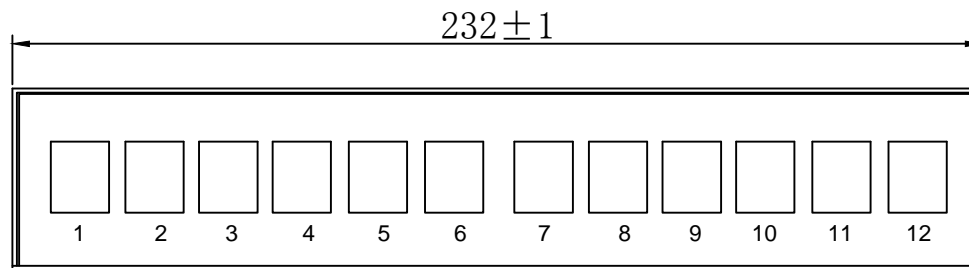
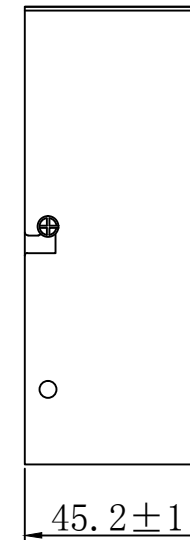
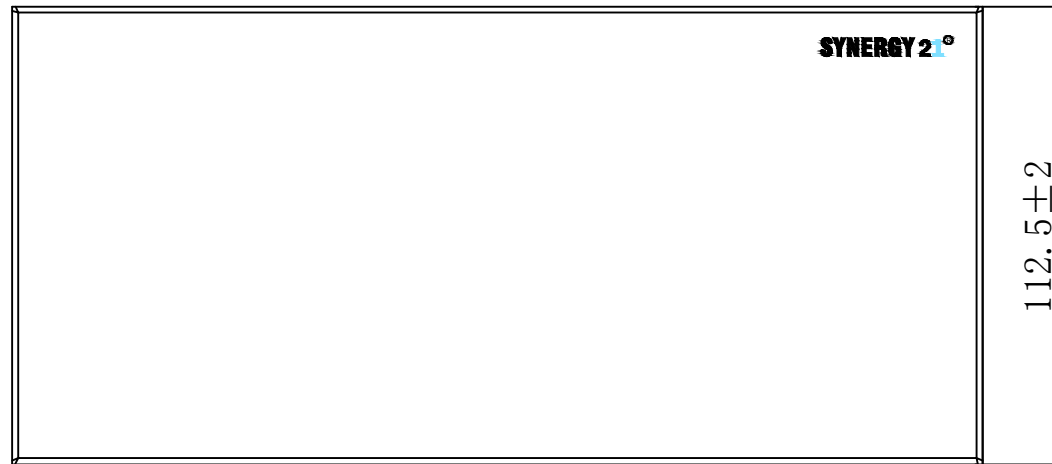
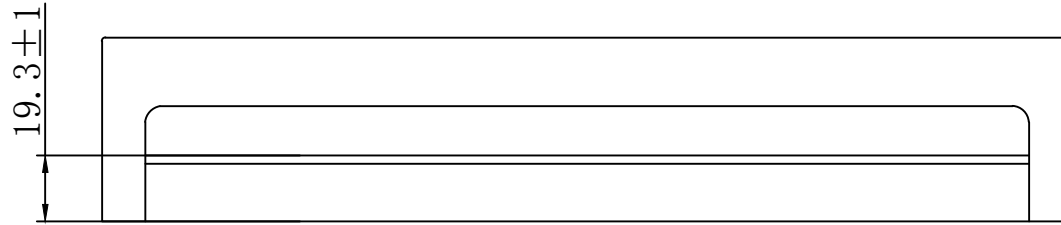

NOTE:

1. RoHS 2.0 and Reach Complinat
 2. PACKING: 1pcs/BOX+labe
- Accessory:
1. Cable Tie (75X1.9mm) × 8Pcs
 2. Foot pad × 4Pcs
 3. M4 Screw × 2pcs

NO.	PARTS NAME	SPECIFICATION STANDARD	QT' Y	REMARK	SYNERGY 21							
②	Top Cover	1.0mm thickness Metallic Panel with plastic powder cladding Gray RAL7035	1		CUSTOMER		ITEM NO.		S216376			
①	Bottom Panel	1.2mm thickness Metallic Panel with plastic powder cladding Gray RAL7035	1		PRODUCT NAME		manufacture country		China UNIT MM			
					Desktop Consolidation Point Box 12 port		DRAWNBY		CHECKBY		APPOBY	
					DATE		SYNERGY 21		SYNERGY 21		SYNERGY 21	
					2020-02-18		A		DATE		2020-02-18	
BY	CHK	REVISION RECORD MODIFICATIONS			DATE		REV.		SYNERGY 21		SYNERGY 21	

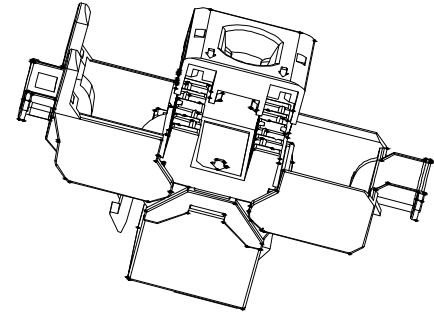
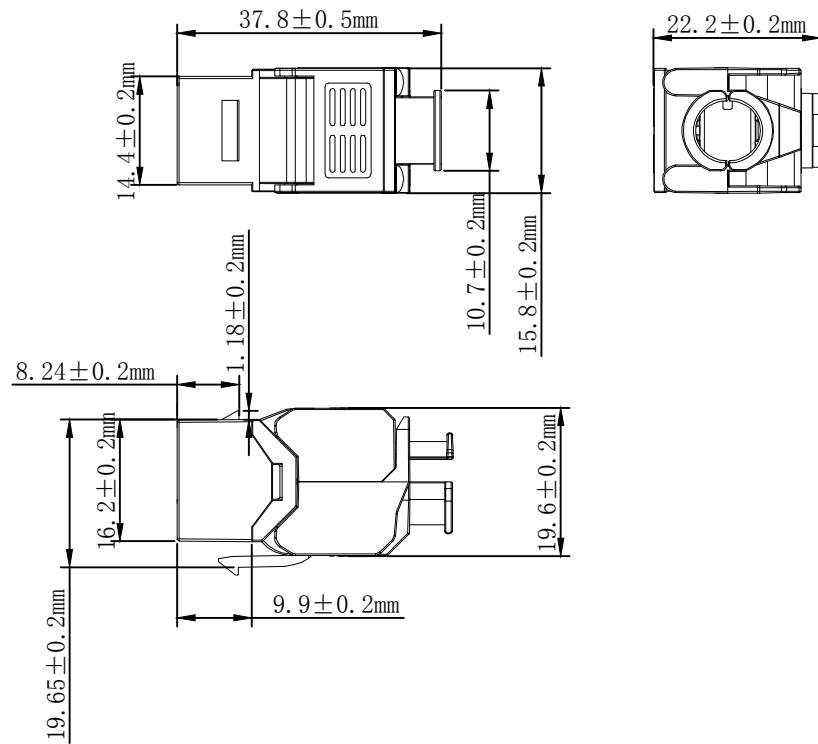
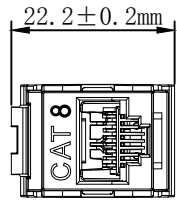

MATERIAL LIST:

⑦	Housing	Zinc alloy Silver	1	
⑥	RJ 45 JACK INSERT	PHOSPHOR BRONZE 8P8C GOLD PLATED	8	
⑤	PCB	FR-4 1.6mm	1	
④	IDC BODY	White PC	1	
③	IDC PIN	PHOSPHOR BRONZE & TINNED	8	
②	LABEL COLOR CODE	T568A/B	2	
①	IDC TERMINAL	FOR 22-26AWG CABLE	1	

NO	PARTS NAME	SPECIFICATION STANDARD	QT'Y	REMARK
		NEW	2020-09-01	A
BY	CHK	REVISION RECORD MODIFICATIONS	DATE	REV.

NOTES:

ELECTRICAL:

- Contact Resistance : 20MΩ MAX
- Insulation Resistance : 500MΩ MIN @ 500V DC
- Withstand Voltage : DC 1000V AC 700V RMS 60Hz, 1MIN
- Compliance with Class I up to 2000 MHz to ISO/IEC 11801-1:2017 (Ed. 1. 0)

ENVIRONMENTAL:

- Storage Temperature : -40°C ~ +70°C
- Operation Temperature : -10°C ~ +60°C

MECHANICAL

- MATERIAL: Zinc alloy
- IDC MATERIAL: PC TERMINAL:PHOSPHOR BRONZE, TIN PLATING
- RJ45 Contact Life: 750 Times Min
- Plug inforce:<30N
- Solid cable:1/22AWG (0.65MM)-1/26AWG (0.4MM) ID:1.1MM-1.6MM
- Stranded cable:22/7-26/7AWG ID:1.1MM-1.6MM
- Cable OD: 5.0mm-8.5mm
- PoE per IEEE 802.3af, PoE+ per IEEE 802.3at,PoE++ per IEEE 802.3bt
- RoHS 2.0 and REACH Compliant
- with copper foil in packing.

SYNERGY 21							
CUSTOMER	ALLNET Computersysteme GmbH	ITEM NO.	S216378				
PRODUCT NAME	CAT 8.1 STP KEYSTONE JACK	manufacture country:	china	UNIT	MM		
DRAWNBY	CHECKBY	APPOBY	DATE				
SYNERGY 21	SYNERGY 21	SYNERGY 21	2020-09-01				

Installationsanleitung/Installation guide

Keystone Jack

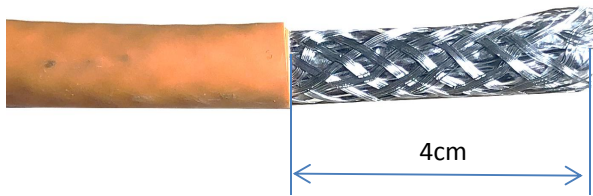

①.Stripping 4cm of sheath.

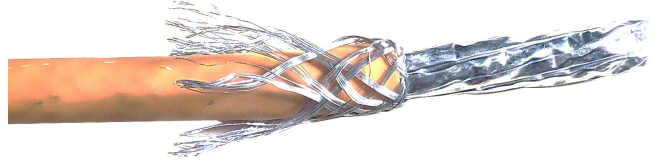

②.foldback braided and drained wire.

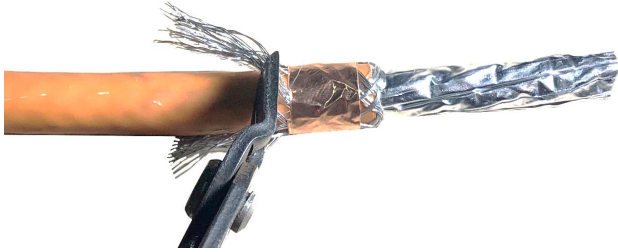

③.paste copper foil on the braided and ground wire and cut off the excess weave and the ground wire

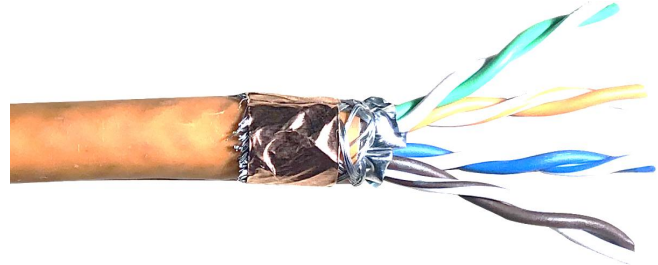

④.4.Fan out all four twisted pairs, allocate each by following colorcoding label

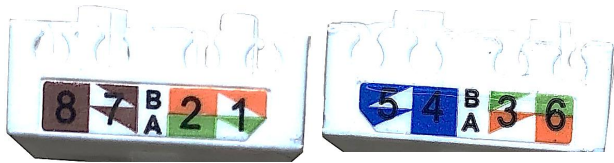

⑤.Across the holde by the color marks of T568A or T568B

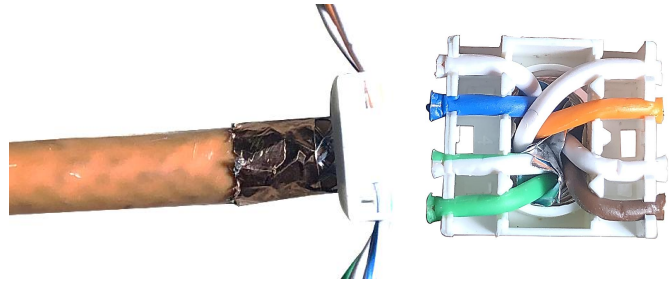

⑥. allocate each conductor into proper slots on wiring cap by following color coding



⑦.Trim the theends of conductors.

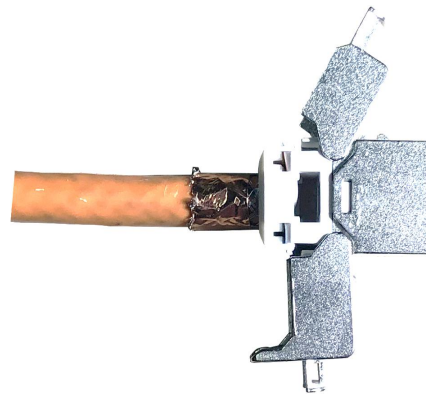

⑧.install the termination cap in direction of arrow into the keystone jack

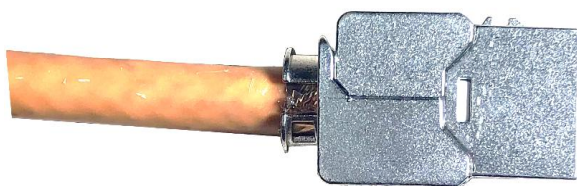

⑨.press both covers of the keystone jack to contact the cable

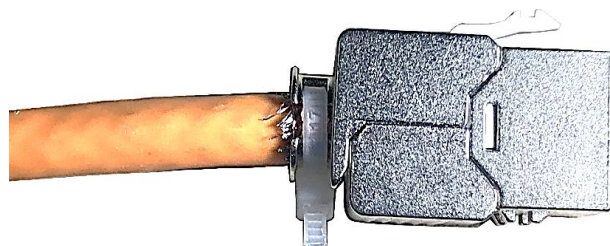

⑩.use cable tie for strain relief and to fix the shielding clamp